

Universal Mounting Bracket System

General Description

Our optional Universal Mounting Bracket allows a radar sign to be easily mounted to virtually any type of pole or surface in a quick, easy and secure manner. The radar sign mounts to the bracket and is just as easily removed from the bracket with the turn of a key. The quick mount and dismount feature of this bracket readily allows the sign to be moved from one location to another with relative ease and convenience.

Features

- Mount to circular, square or Telespar poles
- Promotes sign portability, easily move sign between multiple locations
- Sign locks into mounting bracket with a turn of a key
- Theft resistant design

Specifications

- Use with models: SP100, SP450, SP475, SP550, SP650, EV11, EV12
- Sign bracket: 2 lb.
- Pole bracket: 5 lb.

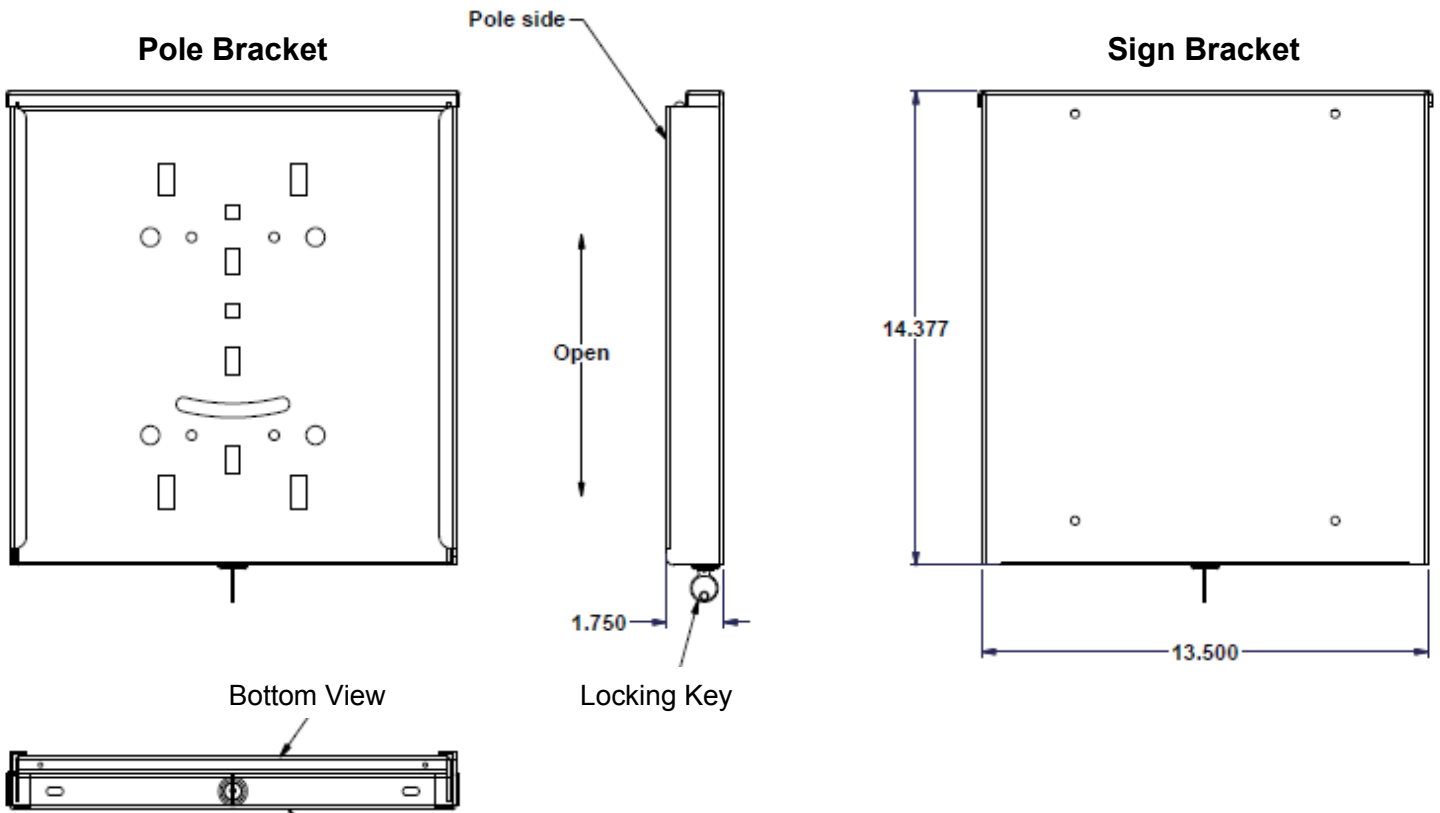

Pole Bracket Inside View

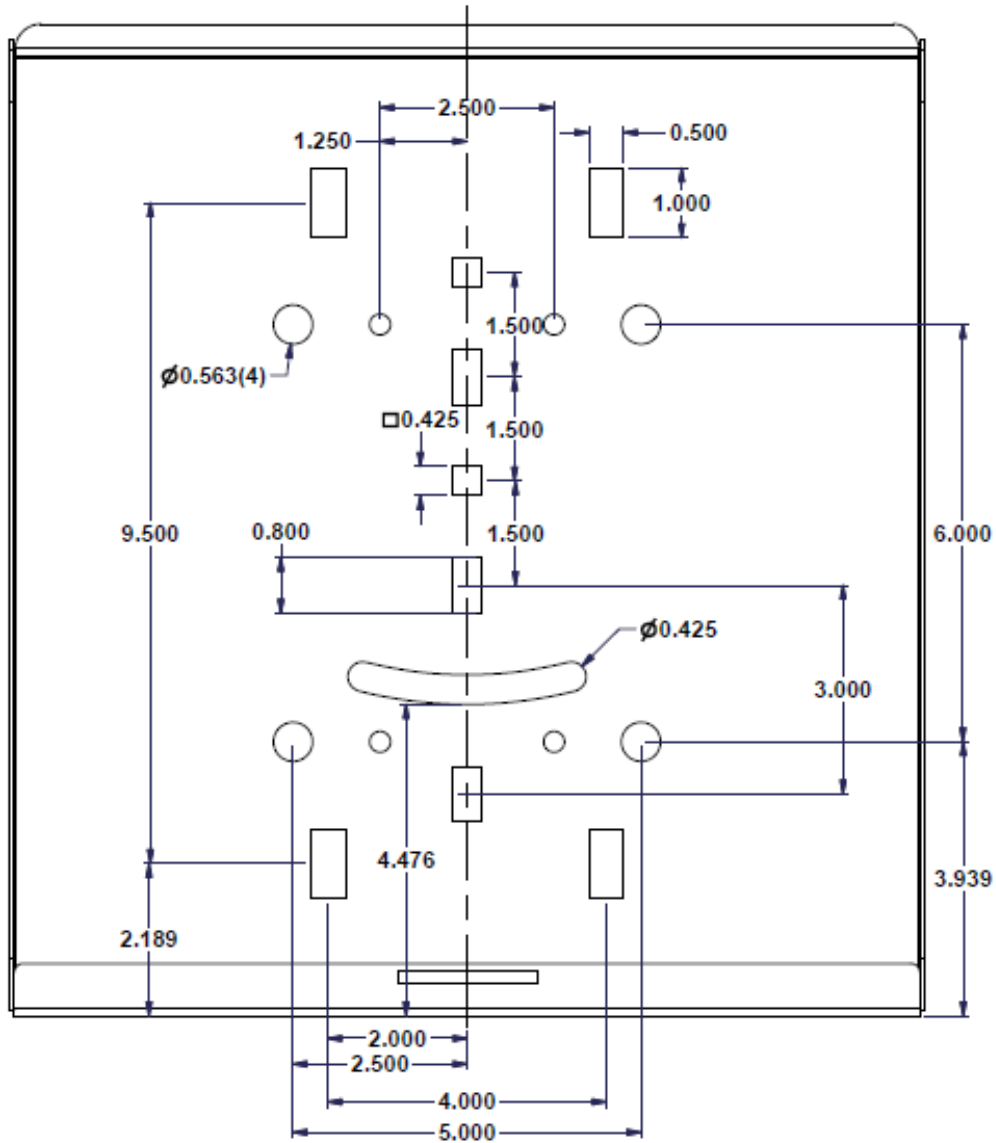

Universal Mounting Bracket System

Installing the Mounting Brackets

Installing Sign Bracket

Attach the Sign Bracket to the backside of the sign using the included hardware.



Figure 1: Use supplied hardware



Figure 2: Backside of Sign Bracket

Installing Pole Bracket

The Pole Bracket can be secured to any type of standard or Telespar type pole by a choice of banding straps, lag screws, or bolts and nuts.



Figure 3: Pole Bracket mounted to circular pole



Figure 4: Pole Bracket mounted to 2" Telespar pole

Installation of Pole Bracket on Telespar Pole

Use the supplied 2.5" stainless steel security bolts and nuts to secure the Pole Bracket to the 2" Telespar pole.



A 2" Telespar pole should be used

It is very important that the head of the bolt be placed on the Telespar pole (See Figures 5 and 6) and that the nuts be placed on the inside part of the bracket (see Figures 7 and 8).

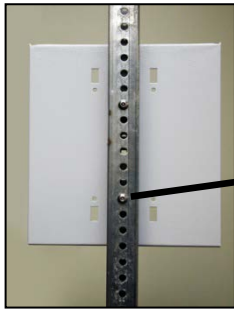

Figure 5

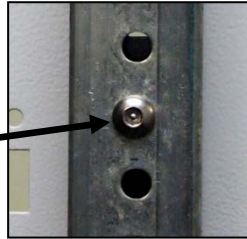

Figure 6



Figure 7

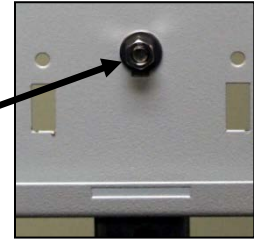

Figure 8

Installation of the Pole Bracket using supplied banding straps

It is highly recommended that if banding is used to secure the Pole Bracket, additional screws and/or bolts should also be used (see Figure 10 below) to further prevent theft and vandalism.



Figure 9: Pole Bracket banded to utility pole

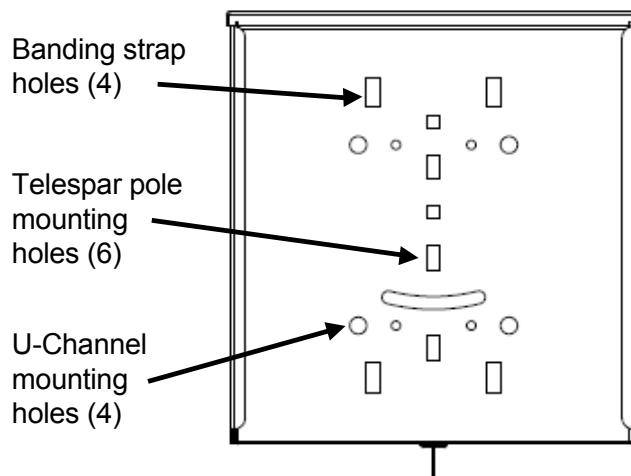

Figure 10: Additional lag bolts should be used for added security



Figure 11: Profile view of Pole Bracket

Pole Bracket



Mounting and Dismounting the Sign

The radar sign easily mounts by sliding the sign down onto the Pole Bracket and dismounts by sliding the sign up off of the Pole Bracket. Once mounted, the sign should be locked into place as shown in Figure 14.

Step 1: Position the sign above the bracket



Figure 12

Step 2: Slide the sign down the bracket



Figure 13

Step 3: Lock the sign in place



Figure 14

Locking mechanism in "unlocked" position

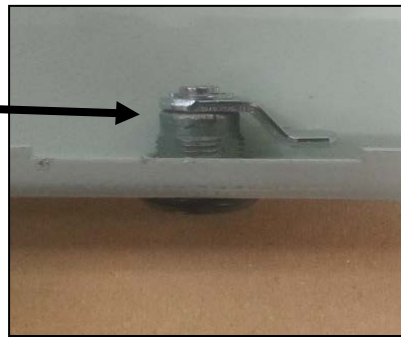

Figure 15



WARNING: To prevent damage to the locking mechanism of the Universal Mounting Bracket System, the key must be removed from the lock and the locking mechanism must be set in the "unlocked" position (see Figure 15) BEFORE sliding the sign ON or OFF of the Pole Bracket.