



Traffic Safety Corporation
2708 47th Ave.
Sacramento, CA 95822-3806
Toll Free: 888.446.9255
Tel: 916.394.9884
Email: sales@xwalk.com
Web: www.xwalk.com

TS-SR-20C Hardwired LED Road Stud

Features

- Appropriate for regular traffic zones and areas of poor visibility.
- Ideal for road delineation, bends/curves, crosswalks among others applications.
- Only .59" (15mm) above road surface.
- High brightness during day and night.
- Low maintenance, 100% waterproof.
- Connect multiple road studs in series circuit.
- Wired system that can be powered by electric or solar energy.
- Low power consumption.
- Internal prismatic system.
- Up to .62 mile (1 km) visibility distance due to high intensity LEDs.
- Many LED color options available for a wide variety of applications.
- Optional hard anodizing or powder coating available for top of road stud.



Specifications

Modes of Operation:

- Always On (other modes of operation like flashing or sequential are available with external controller)

LED Configuration:

- Unidirectional or bidirectional

Electrical:

- Power Supply: 12V DC or 24V DC
- Maximum Current Consumption: 40 mA (depends on LED configuration)
- Power Cable: Brown Wire (+), Blue Wire (-)
- Working Temperature: -13°F to +185°F (-25°C to +85°C)

Optical:

- LED Quantity:
 - 1 or 2 LEDs (Unidirectional)
 - 2 or 4 LEDs (Bidirectional)
- LED Type: 5mm
- LED Colors: White, Red, Yellow, Green, Blue
- Viewing Angle: 15°

Mechanical:

- Material: Aluminum and Polycarbonate
- Mechanical Resistance: 20 tons
- Weight: 2.2 lb. (1 kg)
- Protection Index: IP68, IK10
- Dimensions: 5.67" (144mm) diameter x 3.43" (87mm) height

Other Versions

TS-SR-20CP: Hardwired Road Stud with Power LEDs:

- High visibility due to power LEDs (even in adverse weather conditions).
- Allows drivers a higher reaction time due to extended lighting range.
- Power supply: 12V DC.
- Maximum Current Consumption: 210 mA (depends on LED configuration).
- LED Quantity: 1 (Unidirectional), 2 (Bidirectional).
- Viewing angle: 16°

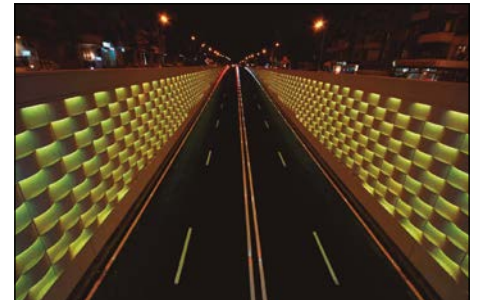

Visit our web site: www.xwalk.com



Traffic Safety Corporation
2708 47th Ave.
Sacramento, CA 95822-3806
Toll Free: 888.446.9255
Tel: 916.394.9884
Email: sales@xwalk.com
Web: www.xwalk.com

TS-SR-20C Hardwired LED Road Stud

Dimensions (mm)

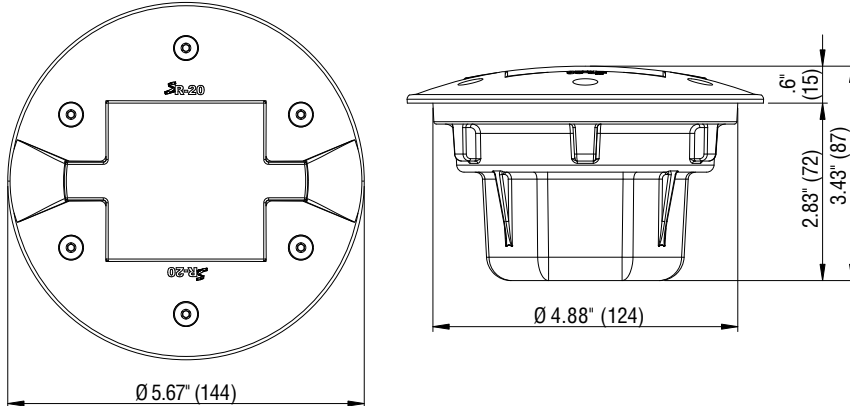

Installation Procedure



Personal protective equipment must be worn during installation process.

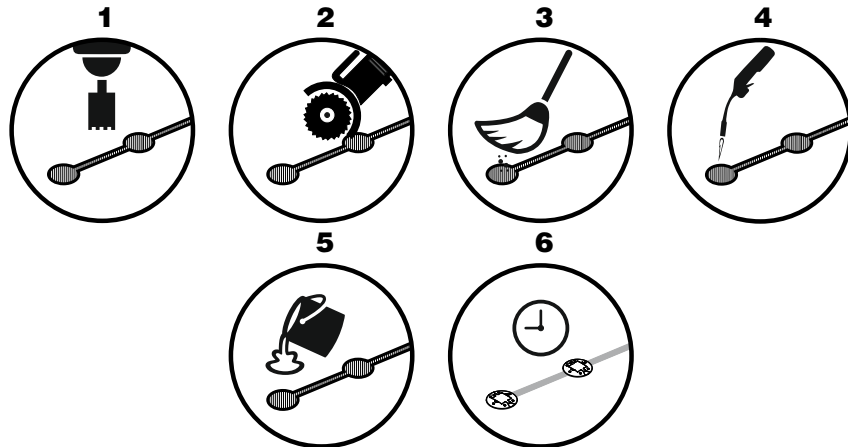

- 1 After deciding the location where the stud will be installed, drill a hole having a minimum diameter of 5.12" (130mm) and 3.15" (80mm) deep.
- 2 Using a disk cutter, open a connection between the holes with .6" (15mm) width and 2.36" (60mm) depth.
- 3 Brush any debris or dust from the hole resulting from drilling.
- 4 Dry the hole with a blowtorch to remove any moisture that may compromise the adhesion and effectiveness of the grout.
- 5 Pour ± 4.4 lb. (± 2 kg) of ULTRAFLOW 4000/8 grout in the hole and insert the stud checking that the LEDs are facing the correct direction. Remove any excess grout.
- 6 The grout drying time may change depending on weather conditions. Consult the grout data sheet for more information.

Changing or not completing the described installation process can result in suspension of warranty.

Visit our web site: www.xwalk.com



Traffic Safety Corporation
 2708 47th Ave.
 Sacramento, CA 95822-3806
 Toll Free: 888.446.9255
 Tel: 916.394.9884
 Email: sales@xwalk.com
 Web: www.xwalk.com

TS-SR-20C Hardwired LED Road Stud

Unidirectional 1 LED

Models

TS-SR-20C-U1W-S-1G
 TS-SR-20C-U1R-S-1G
 TS-SR-20C-U1Y-S-1G
 TS-SR-20C-U1B-S-1G
 TS-SR-20C-U1G-S-1G

Description

Hardwired Road Stud / 3mt Cable Included / 1 LED / Standard CAP / 1 Cable Gland
 "
 "
 "
 "

Color

White
 Red
 Yellow
 Blue
 Green

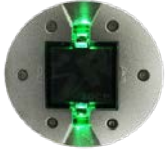

Unidirectional 2 LEDS

Models

TS-SR-20C-U2W-S-1G
 TS-SR-20C-U2R-S-1G
 TS-SR-20C-U2Y-S-1G
 TS-SR-20C-U2B-S-1G
 TS-SR-20C-U2G-S-1G

Description

Hardwired Road Stud / 3mt Cable Included / 2 LED / Standard CAP / 1 Cable Gland
 "
 "
 "
 "

Color

White
 Red
 Yellow
 Blue
 Green

Bidirectional 1+1 LEDS

Models

TS-SR-20C-B2WW-S-1G
 TS-SR-20C-B2RR-S-1G
 TS-SR-20C-B2YY-S-1G
 TS-SR-20C-B2BB-S-1G
 TS-SR-20C-B2GG-S-1G

Description

Hardwired Road Stud / 3mt Cable Included / 2 LED / Standard CAP / 1 Cable Gland
 "
 "
 "
 "

Color

White / White
 Red / Red
 Yellow / Yellow
 Blue / Blue
 Green / Green



Bidirectional 2+2 LEDS

Models

TS-SR-20C-B4WW-S-1G
 TS-SR-20C-B4RR-S-1G
 TS-SR-20C-B4YY-S-1G
 TS-SR-20C-B4BB-S-1G
 TS-SR-20C-B4GG-S-1G

Description

Hardwired Road Stud / 3mt Cable Included / 4 LED / Standard CAP / 1 Cable Gland
 "
 "
 "
 "

Color

White / White
 Red / Red
 Yellow / Yellow
 Blue / Blue
 Green / Green

OBS.:

Cable standard (included): 0.75mm² wire section

Different cable layouts and length should be requested upon order!

Standard mode: Always ON. For flashing or sequential mode, a microcontroller is required.

CAP Options:

Different CAP treatments available by request

Cable Gland:

TS-SR-20C-XXXX-XX-2G

2 Cable Glands

Ref. Example (Color):

TS-SR-20C-XXWR-XX-XX

Side 1 - White / Side 2 - Red

Color combinations:

WR, WY, WB, WG, RY, RB, RG, YB, YG, BG

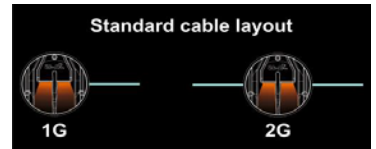

Visit our web site: www.xwalk.com



Traffic Safety Corporation
 2708 47th Ave.
 Sacramento, CA 95822-3806
 Toll Free: 888.446.9255
 Tel: 916.394.9884
 Email: sales@xwalk.com
 Web: www.xwalk.com

TS-SR-20C Hardwired LED Road Stud

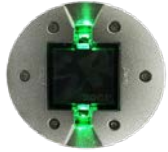

Unidirectional 1 LED

Models

TS-SR-20CP-U1W-S-1G
 TS-SR-20CP-U1R-S-1G
 TS-SR-20CP-U1Y-S-1G
 TS-SR-20CP-U1B-S-1G
 TS-SR-20CP-U1G-S-1G

Description	Color
Hardwired Road Stud / 3mt Cable Included / 1 LED / Standard CAP / 1 Cable Gland	White
"	Red
"	Yellow
"	Blue
"	Green



Bidirectional 1+1 LEDS

Models

TS-SR-20CP-B2WW-S-1G
 TS-SR-20CP-B2RR-S-1G
 TS-SR-20CP-B2YY-S-1G
 TS-SR-20CP-B2BB-S-1G
 TS-SR-20CP-B2GG-S-1G

Description	Color
Hardwired Road Stud / 3mt Cable Included / 2 LED / Standard CAP / 1 Cable Gland	White / White
"	Red / Red
"	Yellow / Yellow
"	Blue / Blue
"	Green / Green

OBS.:

Cable standard (included): 0.75mm² wire section

Different cable layouts and length should be requested upon order!

Standard mode: Always ON. For flashing or sequential mode, a microcontroller is required.

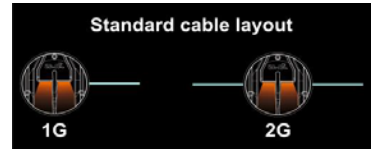

CAP Options:

Different CAP treatments available by request

Cable Gland:
 Ref. Example (Color):
 Color combinations:

TS-SR-20CP-XXXX-XX-2G
 TS-SR-20CP-XXWR-XX-XX

2 Cable Glands
 Side 1 - White / Side 2 - Red

WR, WY, WB, WC, RY, RB, RG, YB, YG, BG

LED Configuration

One road stud with two or more LED colors

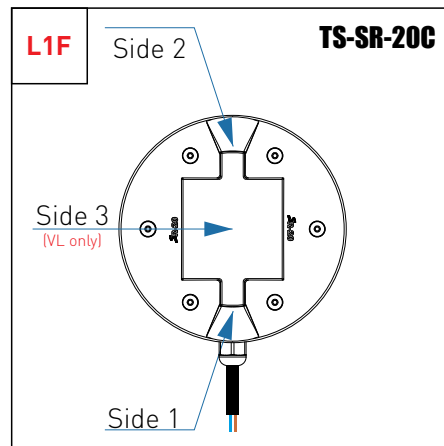
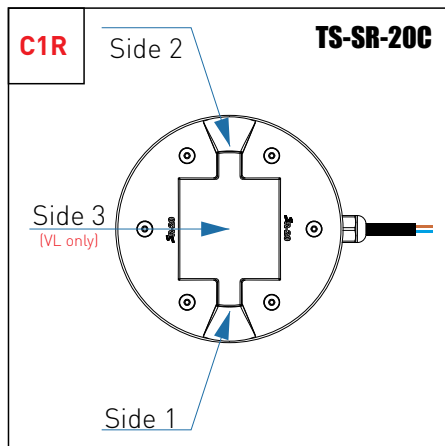

Visit our web site: www.xwalk.com

TS-SR-20C Cable Layout

