



Traffic Safety Corporation  
2708 47th Ave.  
Sacramento, CA 95822-3806  
Toll Free: 888.446.9255  
Tel: 916.394.9884  
Fax: 916.394.2809  
Email: sales@xwalk.com  
Web: www.xwalk.com

## TS-SR-20C Hardwired LED Road Stud

### Features

- Appropriate for regular traffic zones and areas of poor visibility.
- Ideal for road delineation, bends/curves, crosswalks among others applications.
- Only .59" (15mm) above road surface.
- High brightness during day and night.
- Low maintenance, 100% waterproof.
- Connect multiple road studs in series circuit.
- Wired system that can be powered by electric or solar energy.
- Low power consumption.
- Internal prismatic system.
- Up to .62 mile (1 km) visibility distance due to high intensity LEDs.
- Many LED color options available for a wide variety of applications.
- Optional hard anodizing or powder coating available for top of road stud.



### Specifications

#### Modes of Operation:

- Always On (other modes of operation like flashing or sequential are available with external controller)

#### LED Configuration:

- Unidirectional or bidirectional

#### Electrical:

- Power Supply: 12V DC or 24V DC
- Maximum Current Consumption: 40 mA (depends on LED configuration)
- Power Cable: Brown Wire (+), Blue Wire (-)
- Working Temperature: -13°F to +185°F (-25°C to +85°C)

#### Optical:

- LED Quantity:
  - 1 or 2 LEDs (Unidirectional)
  - 2 or 4 LEDs (Bidirectional)
- LED Type: 5mm
- LED Colors: White, Red, Yellow, Green, Blue
- Viewing Angle: 15°

#### Mechanical:

- Material: Aluminum and Polycarbonate
- Mechanical Resistance: 20 tons
- Weight: 2.2 lb. (1 kg)
- Protection Index: IP68, IK10
- Dimensions: 5.67" (144mm) diameter x 3.43" (87mm) height

#### Other Versions

##### TS-SR-20CP: Hardwired Road Stud with Power LEDs:

- High visibility due to power LEDs (even in adverse weather conditions).
- Allows drivers a higher reaction time due to extended lighting range.
- Power supply: 12V DC.
- Maximum Current Consumption: 210 mA (depends on LED configuration).
- LED Quantity: 1 (Unidirectional), 2 (Bidirectional).
- Viewing angle: 16°

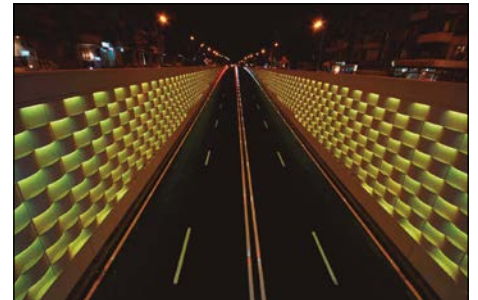

Visit our web site: [www.xwalk.com](http://www.xwalk.com)



Traffic Safety Corporation  
2708 47th Ave.  
Sacramento, CA 95822-3806  
Toll Free: 888.446.9255  
Tel: 916.394.9884  
Fax: 916.394.2809  
Email: sales@xwalk.com  
Web: www.xwalk.com

## TS-SR-20C Hardwired LED Road Stud

### Dimensions (mm)

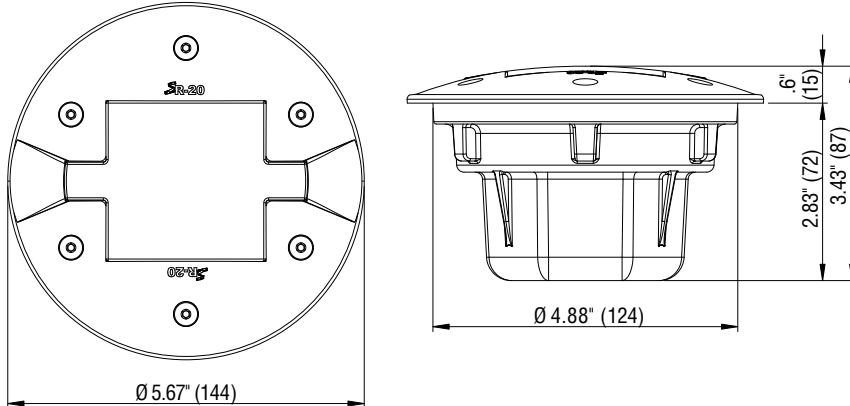

### Installation Procedure



Personal protective equipment must be worn during installation process.

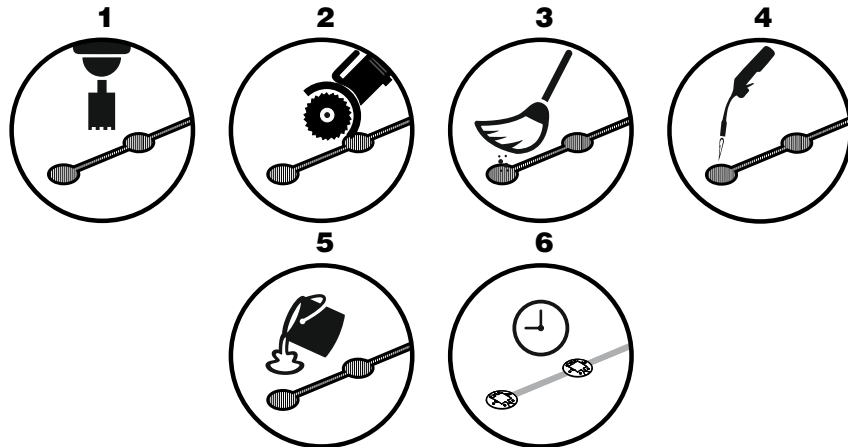

- 1 After deciding the location where the stud will be installed, drill a hole having a minimum diameter of 5.12" (130mm) and 3.15" (80mm) deep.
- 2 Using a disk cutter, open a connection between the holes with .6" (15mm) width and 2.36" (60mm) depth.
- 3 Brush any debris or dust from the hole resulting from drilling.
- 4 Dry the hole with a blowtorch to remove any moisture that may compromise the adhesion and effectiveness of the grout.
- 5 Pour  $\pm 4.4$  lb. ( $\pm 2$  kg) of ULTRAFLOW 4000/8 grout in the hole and insert the stud checking that the LEDs are facing the correct direction. Remove any excess grout.
- 6 The grout drying time may change depending on weather conditions. Consult the grout data sheet for more information.

**Changing or not completing the described installation process can result in suspension of warranty.**

**Visit our web site: [www.xwalk.com](http://www.xwalk.com)**



Traffic Safety Corporation  
 2708 47th Ave.  
 Sacramento, CA 95822-3806  
 Toll Free: 888.446.9255  
 Tel: 916.394.9884  
 Fax: 916.394.2809  
 Email: sales@xwalk.com  
 Web: www.xwalk.com

## TS-SR-20C Hardwired LED Road Stud

### Unidirectional 1 LED

#### Models

TS-SR-20C-U1W-S-1G  
 TS-SR-20C-U1R-S-1G  
 TS-SR-20C-U1Y-S-1G  
 TS-SR-20C-U1B-S-1G  
 TS-SR-20C-U1G-S-1G

#### Description

Hardwired Road Stud / 3mt Cable Included / 1 LED / Standard CAP / 1 Cable Gland  
 "  
 "  
 "  
 "

#### Color

White  
 Red  
 Yellow  
 Blue  
 Green

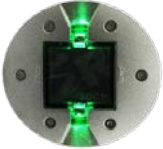

### Unidirectional 2 LEDS

#### Models

TS-SR-20C-U2W-S-1G  
 TS-SR-20C-U2R-S-1G  
 TS-SR-20C-U2Y-S-1G  
 TS-SR-20C-U2B-S-1G  
 TS-SR-20C-U2G-S-1G

#### Description

Hardwired Road Stud / 3mt Cable Included / 2 LED / Standard CAP / 1 Cable Gland  
 "  
 "  
 "  
 "

#### Color

White  
 Red  
 Yellow  
 Blue  
 Green

### Bidirectional 1+1 LEDS

#### Models

TS-SR-20C-B2WW-S-1G  
 TS-SR-20C-B2RR-S-1G  
 TS-SR-20C-B2YY-S-1G  
 TS-SR-20C-B2BB-S-1G  
 TS-SR-20C-B2GG-S-1G

#### Description

Hardwired Road Stud / 3mt Cable Included / 2 LED / Standard CAP / 1 Cable Gland  
 "  
 "  
 "  
 "

#### Color

White / White  
 Red / Red  
 Yellow / Yellow  
 Blue / Blue  
 Green / Green



### Bidirectional 2+2 LEDS

#### Models

TS-SR-20C-B4WW-S-1G  
 TS-SR-20C-B4RR-S-1G  
 TS-SR-20C-B4YY-S-1G  
 TS-SR-20C-B4BB-S-1G  
 TS-SR-20C-B4GG-S-1G

#### Description

Hardwired Road Stud / 3mt Cable Included / 4 LED / Standard CAP / 1 Cable Gland  
 "  
 "  
 "  
 "

#### Color

White / White  
 Red / Red  
 Yellow / Yellow  
 Blue / Blue  
 Green / Green

#### OBS.:

Cable standard (included): 0.75mm<sup>2</sup> wire section

**Different cable layouts and length should be requested upon order!**

Standard mode: Always ON. For flashing or sequential mode, a microcontroller is required.

#### CAP Options:

Different CAP treatments available by request

#### Cable Gland:

TS-SR-20C-XXXX-XX-2G

2 Cable Glands

#### Ref. Example (Color):

TS-SR-20C-XXWR-XX-XX

Side 1 - White / Side 2 - Red

#### Color combinations:

WR, WY, WB, WG, RY, RB, RG, YB, YG, BG

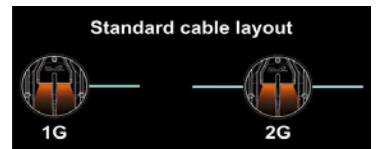

**Visit our web site: [www.xwalk.com](http://www.xwalk.com)**



Traffic Safety Corporation  
 2708 47th Ave.  
 Sacramento, CA 95822-3806  
 Toll Free: 888.446.9255  
 Tel: 916.394.9884  
 Fax: 916.394.2809  
 Email: sales@xwalk.com  
 Web: www.xwalk.com

## TS-SR-20C Hardwired LED Road Stud

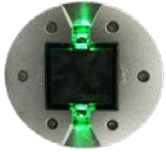

**Unidirectional 1 LED**

**Models**

TS-SR-20CP-U1W-S-1G  
 TS-SR-20CP-U1R-S-1G  
 TS-SR-20CP-U1Y-S-1G  
 TS-SR-20CP-U1B-S-1G  
 TS-SR-20CP-U1G-S-1G

<i>Description</i>	<i>Color</i>
Hardwired Road Stud / 3mt Cable Included / 1 LED / Standard CAP / 1 Cable Gland	White
"	Red
"	Yellow
"	Blue
"	Green



**Bidirectional 1+1 LEDs**

**Models**

TS-SR-20CP-B2WW-S-1G  
 TS-SR-20CP-B2RR-S-1G  
 TS-SR-20CP-B2YY-S-1G  
 TS-SR-20CP-B2BB-S-1G  
 TS-SR-20CP-B2GG-S-1G

<i>Description</i>	<i>Color</i>
Hardwired Road Stud / 3mt Cable Included / 2 LED / Standard CAP / 1 Cable Gland	White / White
"	Red / Red
"	Yellow / Yellow
"	Blue / Blue
"	Green / Green

**OBS.:**

Cable standard (included): 0.75mm<sup>2</sup> wire section

**Different cable layouts and length should be requested upon order!**

Standard mode: Always ON. For flashing or sequential mode, a microcontroller is required.

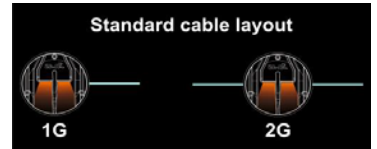

**CAP Options:**

Different CAP treatments available by request

**Cable Gland:**

TS-SR-20CP-XXXX-XX-2G

2 Cable Glands

**Ref. Example (Color):**

TS-SR-20CP-XXWR-XX-XX

Side 1 - White / Side 2 - Red

**Color combinations:**

WR, WY, WB, WC, RY, RB, RG, YB, YG, BG

**Visit our web site: [www.xwalk.com](http://www.xwalk.com)**